

2020

## İZOLATÖRLER



## İZOLATÖRLER



## BARALAR

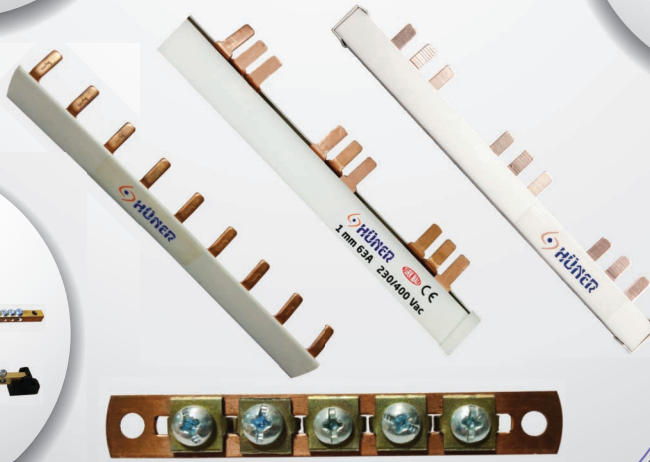

## TARAK İZOLATÖRLER

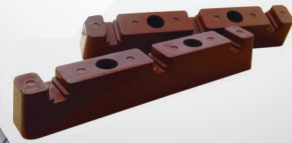

## TARAK İZOLATÖRLER



## KLEMENSLER



## TOPRAKLAMA KLEMENSLERİ

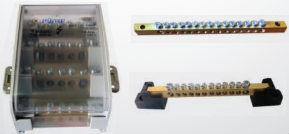

## SKP





Elektrolitik Bakır,  
Plastik Yan Kapaklı

**YENİ**



Elektrolitik Bakır



Elektrolitik Bakır,  
Nikel Kaplamalı Vidalar



### TRİFAZE W OTOMAT BARASI

80A

KOD	AÇIKLAMA	MODÜL	KOLİ AD.	KUTU AD.	FİYAT ₺
52940-Y	1 mm Elektrolitik Bakır 53 cm	10	150	25	41,00 ₺
52960-Y	1 mm Elektrolitik Bakır 106 cm	20	50	25	82,00 ₺

### TRİFAZE W OTOMAT BARASI

80A

KOD	AÇIKLAMA	MODÜL	KOLİ AD.	KUTU AD.	FİYAT ₺
52940	1 mm Elektrolitik Bakır 53 cm	10	150	25	54,00 ₺
52960	1 mm Elektrolitik Bakır 106 cm	20	50	25	108,00 ₺

### TRİFAZE W OTOMAT BARASI

100A

KOD	AÇIKLAMA	MODÜL	KOLİ AD.	KUTU AD.	FİYAT ₺
52941	1,5 mm Elektrolitik Bakır 53 cm	10	150	25	85,00 ₺
52961	1,5 mm Elektrolitik Bakır 106 cm	20	50	25	170,00 ₺
52966	Trifaze Bara Nihayet Kapağı				0,41 ₺

### MONAFAZE W OTOMAT BARASI

KOD	AÇIKLAMA	MODÜL	KOLİ AD.	KUTU AD.	FİYAT ₺
52943	1 mm Elektrolitik Bakır 53 cm	30	300	50	19,50 ₺
52963	1 mm Elektrolitik Bakır 106 cm	60	100	50	39,00 ₺
52942	1,5 mm Elektrolitik Bakır 53 cm	30	300	50	33,60 ₺
52962	1,5 mm Elektrolitik Bakır 106 cm	60	100	50	66,00 ₺

### NÖTR TOPRAKLAMA BARASI

KOD	AÇIKLAMA	VİDA	KUTU AD.	FİYAT ₺
52944	15 x 1,5 mm x 1 metre	31	20	62,00 ₺
52948	15 x 1,5 mm x 1 metre	61	20	68,00 ₺
52945	15 x 2 mm x 1 metre	31	20	81,00 ₺
52949	15 x 2 mm x 1 metre	61	20	90,00 ₺
52946	15 x 3 mm x 1 metre	31	20	124,00 ₺
52947	15 x 3 mm x 1 metre	61	20	133,00 ₺

### NÖTR BARA MESNEDİ

KOD	AÇIKLAMA	KUTU AD.	FİYAT ₺
52950	Nötr Bara Mesnedi	150	3,75 ₺

### M5 MİNİ İZOLATÖR 25MM

KOD	AÇIKLAMA	KOLİ AD.	KUTU AD.	FİYAT ₺
57219	BMI-M 5/2C	1500	250	1,37 ₺
57220	BMI-M 5/1C + 1S	1500	250	1,75 ₺
57221	BMI-M 5/2S	1500	250	2,37 ₺

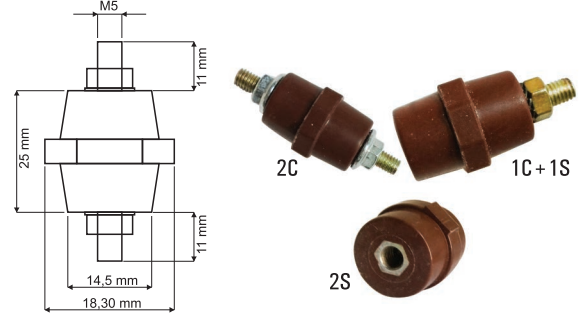

### M6 MİNİ BOY FIÇI İZOLATÖR 30MM

KOD	AÇIKLAMA	KOLİ AD.	KUTU AD.	FİYAT ₺
57222	BMI-M 6/2 C	900	150	2,44 ₺
57223	BMI-M 6/1 C + 1 S	900	150	2,78 ₺
57224	BMI-M 6/2 S	900	150	3,18 ₺

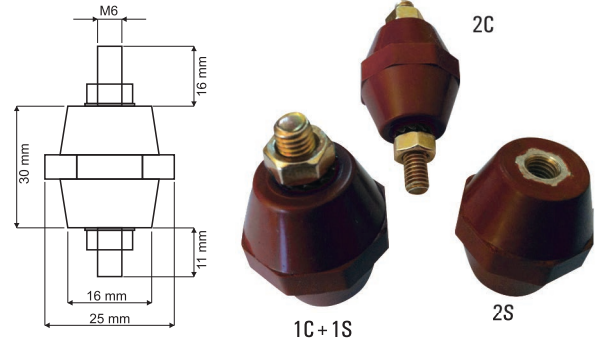

### M8 ORTA BOY FIÇI İZOLATÖR 35MM

KOD	AÇIKLAMA	KOLİ AD.	KUTU AD.	FİYAT ₺
57236	BMI-M 8/2 C	400	50	3,70 ₺
57237	BMI-M 8/1 C + 1 S	400	50	4,00 ₺
57238	BMI-M 8/2 S	400	50	4,16 ₺

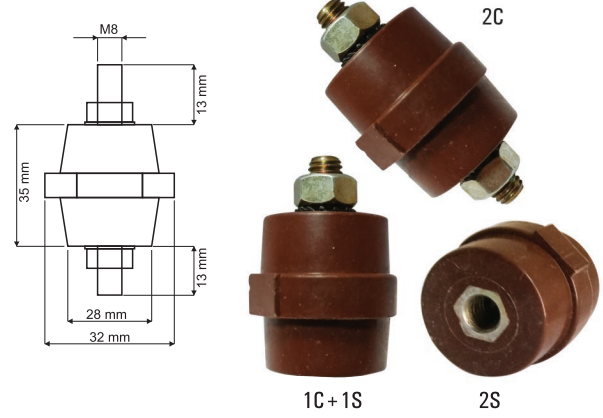

### M6 ORTA BOY KONİK İZOLATÖR

KOD	AÇIKLAMA	KOLİ AD.	KUTU AD.	FİYAT ₺
57225	BMI-M 6/2 C	600	100	2,60 ₺
57226	BMI-M 6/1 C + 1 S	600	100	3,00 ₺
57227	BMI-M 6/2 S	600	100	3,35 ₺

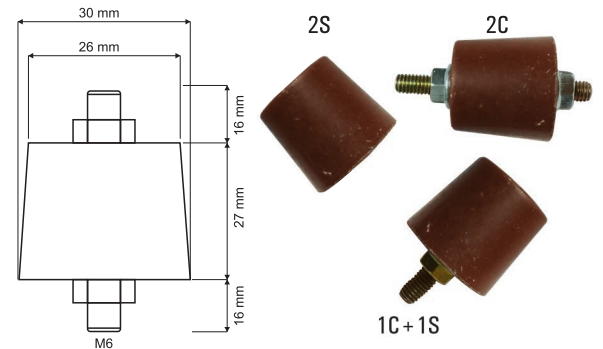



### BARA TUTUCU SERFİL

SAÇ KALINLIĞI 5MM

KOD	AÇIKLAMA	KOLİ AD.	KUTU AD.	FİYAT ₺
57240	BMS (M 8 - M 10)	300	50	4,20 ₺



-  2c : İki tarafı civatalı izolatör
-  1c + 1s : Bir tarafı civatalı bir tarafı kör somunlu izolatör
-  2s : İki tarafı kör somunlu izolatör

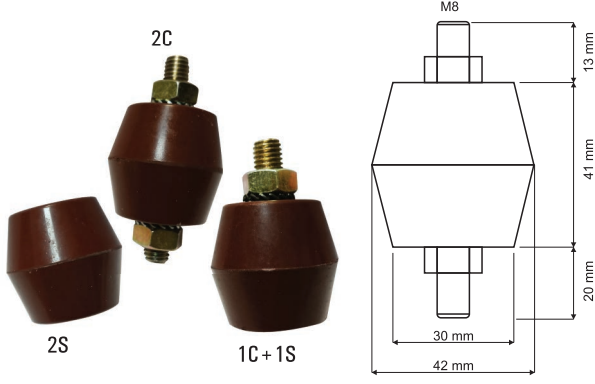

#### 40mm BÜYÜK BOY FIÇI İZOLATÖR (M8)

KOD	AÇIKLAMA	KOLİ AD.	KUTU AD.	FİYAT ₺
57228	BMI-M 8/2C	240	40	5,33 ₺
57232	BMI-M 8/1C + 1S	240	40	6,37 ₺
57230	BMI-M 8/2S	240	40	6,20 ₺

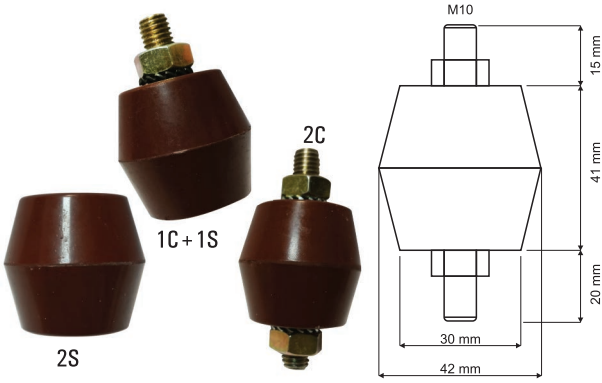

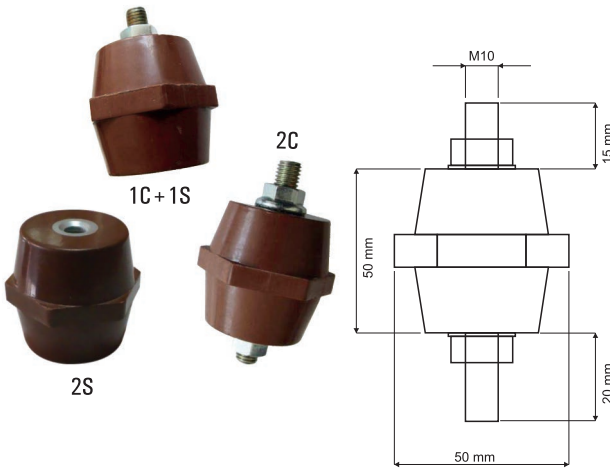

#### 40mm BÜYÜK BOY FIÇI İZOLATÖR (M10)

KOD	AÇIKLAMA	KOLİ AD.	KUTU AD.	FİYAT ₺
57229	BMI-M 10/2 C	240	40	7,55 ₺
57233	BMI-M 10/1 C + 1 S	240	40	7,45 ₺
57231	BMI-M 10/2 S	240	40	7,30 ₺



#### 50mm BÜYÜK BOY FIÇI İZOLATÖR

KOD	AÇIKLAMA	KOLİ AD.	KUTU AD.	FİYAT ₺
57241	BMI-M 10/2 C	120	20	9,35 ₺
57242	BMI-M 10/1 C + 1 S	120	20	9,60 ₺
57243	BMI-M 10/2 S	120	20	10,50 ₺

-  **2c** : İki tarafı civatalı izolatör
-  **1c + 1s** : Bir tarafı civatalı bir tarafı kör somunlu izolatör
-  **2s** : İki tarafı kör somunlu izolatör

## 1NK İZOLATÖR

KOD	AÇIKLAMA	KOLİ AD.	KUTU AD.	FİYAT ₺
57264	1NK-500 İzolatör M16 (Tepe Kuvveti 500 Kg.)	72	12	20,40 ₺

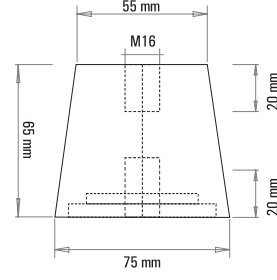

## 1N-500 İZOLATÖRLER

KOD	AÇIKLAMA	KOLİ AD.	KUTU AD.	FİYAT ₺
57265	1N-500 Mesnet İzolatörü (M10)	120	20	11,25 ₺
57266	1N-500 Mesnet İzolatörü (M12)	120	20	15,00 ₺

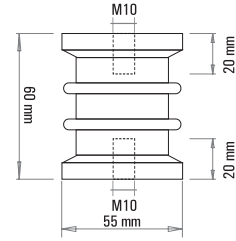

## 1N-1000 İZOLATÖRLER

KOD	AÇIKLAMA	KOLİ AD.	KUTU AD.	FİYAT ₺
57267	1N-1000 Mesnet İzolatörü (M12)	40	20	34,15 ₺
57268	1N-1000 Mesnet İzolatörü (M16)	40	20	34,65 ₺

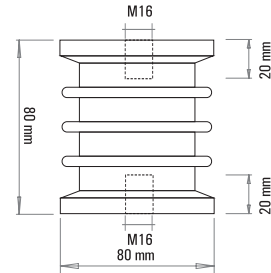

## İZOLATÖRLERİMİZDE KULLANDIĞIMIZ CİVATA ve SOMUNLAR



## TARAK İZOLATÖRLER

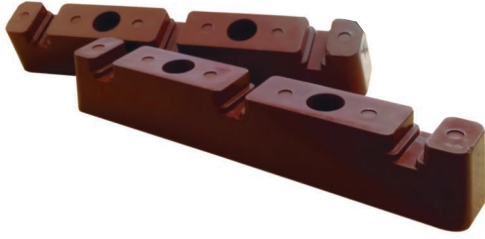

KOD	AÇIKLAMA	KOLİ AD.	KUTU AD.	FİYAT AD. ₺
57244	3 x 1F Tarak İzolator (KISA TİP)	120	20	6,70 ₺

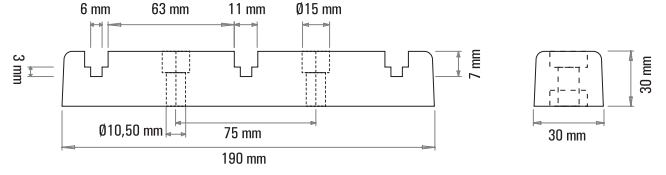

KOD	AÇIKLAMA	KOLİ AD.	KUTU AD.	FİYAT AD. ₺
57245	3 x 1F Tarak İzolator (UZUN TİP)	80	40	9,90 ₺

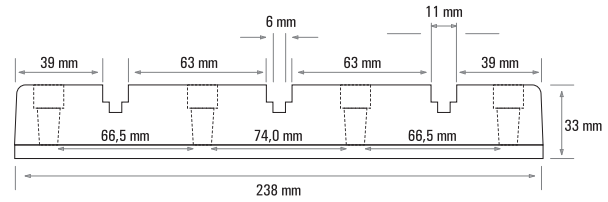

KOD	AÇIKLAMA	KOLİ AD.	KUTU AD.	FİYAT AD. ₺
57246	3 x 2F Tarak İzolator	80	40	10,60 ₺

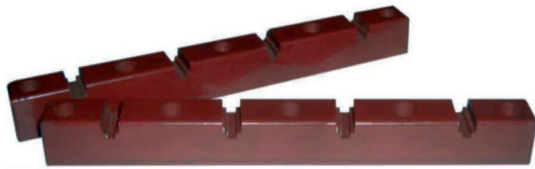
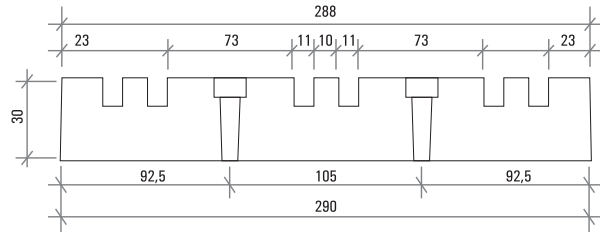

KOD	AÇIKLAMA	KOLİ AD.	KUTU AD.	FİYAT AD. ₺
57247	3 x 1F + N (4x1F) Tarak İzolator	80	40	10,90 ₺

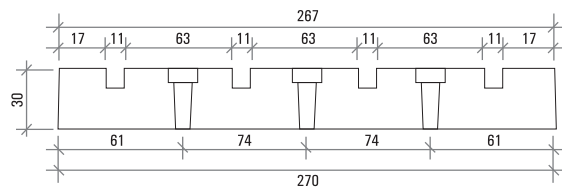

KOD	AÇIKLAMA	KOLİ AD.	KUTU AD.	FİYAT AD. ₺
57248	3 x 2F + N Tarak İzolator	72	8	13,95 ₺

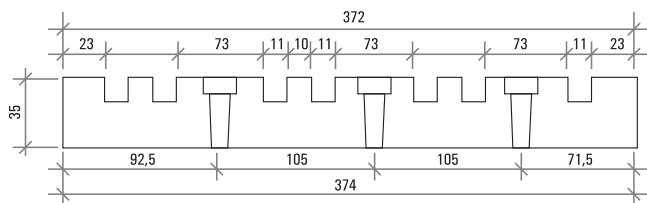

## TARAK İZOLATÖRLER

\*%70 POLYAMİD %30 CAM ELYAF KATKILIDIR.

### KÜÇÜK

USD

KOD	AÇIKLAMA	KOLİ AD.	KUTU AD.	FİYAT AD. \$
57030	3 x 1F Tarak İzolatör (siyah)	180	30	1,55 \$

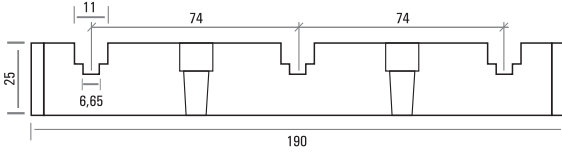

### BÜYÜK

USD

KOD	AÇIKLAMA	KOLİ AD.	KUTU AD.	FİYAT AD. \$
57032	3 x 1F Tarak İzolatör (siyah)	132	22	2,35 \$

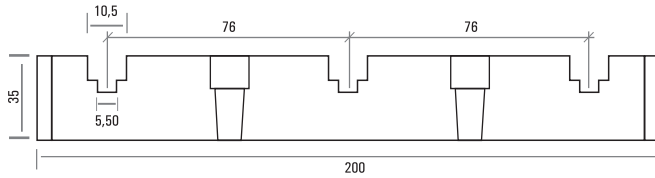

USD

KOD	AÇIKLAMA	KOLİ AD.	KUTU AD.	FİYAT AD. \$
57031	3 x 2F Tarak İzolatör (siyah)	100	50	2,55 \$

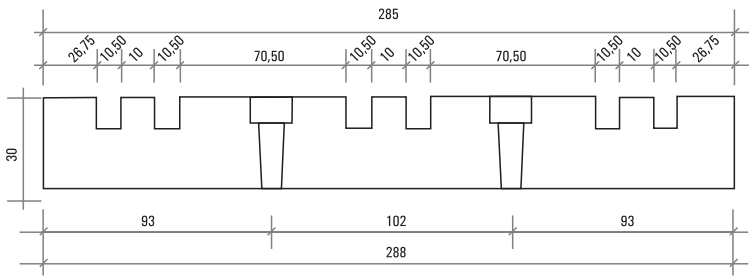

USD

KOD	AÇIKLAMA	KOLİ AD.	KUTU AD.	FİYAT AD. \$
57035	3F x 2F Tarak İzolatör (siyah)	240	40	1,15 \$

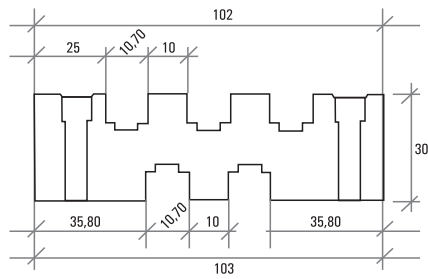

USD

KOD	AÇIKLAMA	KOLİ AD.	KUTU AD.	FİYAT AD. \$
57037	4 X 1F		12	3,70 \$



## TARAK İZOLATÖRLER

USD

KOD	AÇIKLAMA	KOLİ AD.	KUTU AD.	FİYAT AD. \$
57033	1 X 5 X 3F + 1 X 10 X 3F	180	30	2,90 \$
57034	2 X 5 X 3F + 2 X 10 X 3F	180	30	2,90 \$
57036	2 X 5 X 3F + 1 X 10 X 3F	180	30	2,90 \$





### DÜZ SAC RAYLAR

35x7,5

KOD	AÇIKLAMA	UZUNLUK	KOLİ AD.	FİYAT ₺
52902	Düz Sac Ray	30 cm	50	2,40 ₺
52901	Düz Sac Ray	1m.	50	7,24 ₺
52911	Düz Sac Ray	2m.	50	14,50 ₺



### DELİKLİ SAC RAYLAR

35x7,5

KOD	AÇIKLAMA	UZUNLUK	KOLİ AD.	FİYAT ₺
52904	Delikli Sac Ray	30 cm	50	2,40 ₺
52903	Delikli Sac Ray	1m.	50	7,24 ₺
52913	Delikli Sac Ray	2m.	50	14,50 ₺



### DÜZ ALÜMİNYUM RAYLAR

35x7,5

KOD	AÇIKLAMA	UZUNLUK	KOLİ AD.	FİYAT ₺
52905	Düz Alüminyum Ray	1m.	35	16,80 ₺
52906	Düz Alüminyum Ray	30 cm.	35	5,60 ₺



### DELİKLİ ALÜMİNYUM RAYLAR

35x7,5

KOD	AÇIKLAMA	UZUNLUK	KOLİ AD.	FİYAT ₺
52907	Delikli Alüminyum Ray	1m.	35	17,50 ₺
52908	Delikli Alüminyum Ray	30 cm.	35	5,80 ₺



### ALÜMİNYUM RAY TAŞIYICI

KOD	AÇIKLAMA	KOLİ AD.	FİYAT ₺
52951	Alüminyum Ray Taşıyıcı	150	2,60 ₺



### SAC RAY TAŞIYICI

KOD	AÇIKLAMA	KOLİ AD.	FİYAT ₺
52956	Sac Ray Taşıyıcı	150	2,25 ₺

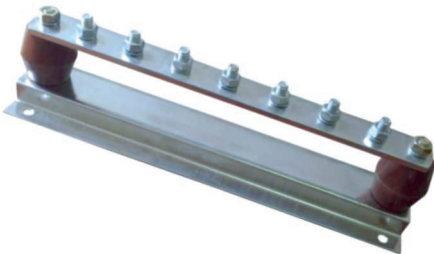

### EŞ POTANSİYEL BARALAR

KOD	AÇIKLAMA	KUTU AD.	FİYAT ₺
52925	30x3 21 cm 5 civatalı	1	69,50 ₺
52931	30x3 25 cm 10 civatalı	1	81,20 ₺
52926	30x3 30 cm 7 civatalı	1	91,20 ₺
52927	30x5 21 cm 5 civatalı	1	99,90 ₺
52928	30x5 30 cm 7 civatalı	1	128,00 ₺
52929	30x5 40 cm 9 civatalı	1	166,50 ₺
52930	30x5 50 cm 12 civatalı	1	204,00 ₺
52923	40x5 21 cm 5 civatalı	1	118,00 ₺
52924	40x5 30 cm 7 civatalı	1	162,00 ₺
52933	40x5 40 cm 9 civatalı	1	208,00 ₺
52934	40x5 50 cm 12 civatalı	1	260,00 ₺



### SKP KABLO PABUÇU TİP 1 Kalay Kaplamalı E-Bakır

KOD	KESİT mm <sup>2</sup>	D	L	D1	D2	KUTU AD.	FİYAT ₺
57172	16	M6	30	5,5	5,8	500	1,28 ₺
57173	25	M8	40	7	7,2	350	2,55 ₺
57174	35	M8	44	8,5	8,5	200	3,40 ₺
57175	50	M10	52	10	10	150	4,25 ₺
57176	70	M10	55	10	11,5	100	7,00 ₺
57177	95	M12	59	10	13,5	80	8,10 ₺
57178	120	M12	70	13	15,6	50	11,46 ₺
57179	150	M12	77	17	17	40	18,26 ₺
57180	185	M16	85	17	19	30	21,87 ₺
57181	240	M16	90	17	21	25	31,84 ₺



### SKP KABLO PABUÇU TİP 2 (Uzun) Kalay Kaplamalı E-Bakır

KOD	KESİT mm <sup>2</sup>	Civata	L	D1	D2	KUTU AD.	FİYAT ₺
57071	10	M5	27,5	5	6,5	800	1,29 ₺
		M6	27,5	5	6,5	800	1,33 ₺
		M8	27,5	5	6,5	800	1,47 ₺
57072	16	M6	30	5,8	7,8	500	1,78 ₺
		M8	30	5,8	7,8	500	1,98 ₺
57073	25	M6	40	7,2	9,5	350	3,37 ₺
		M8	40	7,2	9,5	350	3,17 ₺
		M10	40	7,2	9,5	350	3,37 ₺
57074	35	M6	44	8,5	11	200	4,56 ₺
		M8	44	8,5	11	200	4,36 ₺
		M10	44	8,5	11	200	4,46 ₺
57075	50	M8	52	10	13	150	6,74 ₺
		M10	52	10	13	150	6,54 ₺
		M12	52	10	13	150	6,74 ₺
57076	70	M8	55	11,5	14,7	100	9,31 ₺
		M10	55	11,5	14,7	100	8,92 ₺
		M12	55	11,5	14,7	100	9,31 ₺
57077	95	M8	59	13,5	16,7	80	11,29 ₺
		M10	59	13,5	16,7	80	10,80 ₺
		M12	59	13,5	16,7	80	10,80 ₺
57078	120	M10	70	15,6	19	50	15,46 ₺
		M12	70	15,6	19	50	15,46 ₺
57079	150	M10	77	17	21	40	25,16 ₺
		M12	77	17	21	40	24,77 ₺
57080	185	M10	85	19	23	30	28,73 ₺
		M12	85	19	23	30	28,73 ₺
		M16	85	19	23	30	28,73 ₺
57081	240	M10	90	21	26	25	40,62 ₺
		M12	90	21	26	25	39,63 ₺
		M16	90	21	26	25	39,63 ₺
57082	300	M12	100	23,5	28,6	20	50,53 ₺
		M16	100	23,5	28,6	20	50,53 ₺
57083	400	M12	108	26,8	32,8	12	79,26 ₺
		M16	108	26,8	32,8	12	79,26 ₺
		M20	108	26,8	32,8	12	83,22 ₺

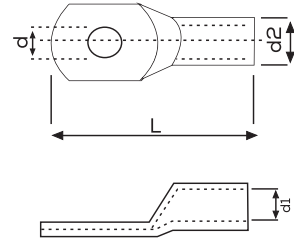



### ALÜMİNYUM SKP

KOD	KESİT	DELİK ÇAPI	İÇ ÇAP	DIŞ ÇAP	UZUNLUK	KUTU AD.	FİYAT ₺
62970	16'lık	6	5,6	10	60	200	1,10 ₺
62971	25'lik	8	7	12	70	150	1,70 ₺
62972	35'lik	8	8,2	14	76	100	2,40 ₺
62973	50'lik	10	10	16	83	75	3,15 ₺
62974	70'lik	12	11,40	18	97	50	4,00 ₺
62975	95'lik	12	13,40	22	109	50	5,00 ₺
62976	120'lik	12	15	22	109	40	5,95 ₺
62977	150'lik	12	16,50	26	118,5	25	9,15 ₺
62978	185'lik	12	18,50	28	125,5	20	10,30 ₺
62979	240'lik	12	21,2	32	141,5	20	11,30 ₺



### AL-CU SKP

KOD	KESİT	DELİK ÇAPI	İÇ ÇAP	DIŞ ÇAP	UZUNLUK	KUTU AD.	FİYAT ₺
72981	16'lık	6	5,6	10	60	200	3,10 ₺
72982	25'lik	8	7	12	70	150	3,60 ₺
72983	35'lik	8	8,2	14	76	100	4,15 ₺
72984	50'lik	10	10	16	83	75	5,00 ₺
72985	70'lik	12	11,40	18	97	50	5,75 ₺
72986	95'lik	12	13,40	22	109	50	8,90 ₺
72987	120'lik	12	15	22	109	40	10,40 ₺
72988	150'lik	12	16,50	26	118,5	25	16,10 ₺
72989	185'lik	12	18,50	28	125,5	20	16,25 ₺
72990	240'lik	12	21,2	32	141,5	20	16,65 ₺



### İTHAL AL-CU KABLO PABUCU

KOD	KUTU AD.	KABLO KESİTİ	METRİK(mm <sup>2</sup> )	BİRİM FİYAT \$
92970	80	SC 16-8	M8	3,10 \$
92971	80	SC 25-8	M8	3,10 \$
92972	40	SC 35-8	M8	3,10 \$
92973	40	SC 50-10	M10	3,71 \$
92974	40	SC 70-10	M10	3,71 \$
92975	40	SC 95-12	M12	4,00 \$
92976	20	SC 120-12	M12	6,62 \$
92977	20	SC 150-12	M12	6,75 \$
92978	16	SC 185-16	M16	8,82 \$
92979	16	SC 240-16	M16	10,00 \$



### İTHAL AL-CU SKP'LER İÇİN (Z) BAĞLANTI APARATI

KOD	AÇIKLAMA	KUTU AD.	BİRİM FİYAT ₺
52980	Al-Cu Skp'ler İçin Bağlantı Aparatı	100	10,20 ₺

### BAKIR SIKMALI EK MUFLAR

KOD	KESİT mm <sup>2</sup>	KUTU AD.	FİYAT ₺
57087	16	250	2,45 ₺
57088	25	250	3,93 ₺
57089	35	200	6,00 ₺
57090	50	150	7,17 ₺
57091	70	100	11,30 ₺
57092	95	50	13,15 ₺
57093	120	50	17,50 ₺
57094	150	40	20,00 ₺
57095	185	30	31,50 ₺
57096	240	25	43,85 ₺



### ALÜMİNYUM SIKMALI EK MUFLAR

KOD	KESİT mm <sup>2</sup>	KUTU AD.	FİYAT ₺
82970	16	200	1,10 ₺
82971	25	125	1,70 ₺
82972	35	100	2,40 ₺
82973	50	75	3,15 ₺
82974	70	50	4,00 ₺
82975	95	40	5,00 ₺
82976	120	25	5,95 ₺
82977	150	20	9,15 ₺
82978	185	15	10,30 ₺
82979	240	15	11,30 ₺



### U KLEMENSLER

KOD	AÇIKLAMA	KUTU AD.	FİYAT ₺
57020	6'lık U Klemens	150	2,54 ₺
57021	10'luk U Klemens	125	3,62 ₺
57022	16'lık U Klemens	100	4,75 ₺
57023	25'lik U Klemens	100	6,40 ₺
57024	35'lik U Klemens	75	7,50 ₺
57025	50'lik U Klemens	50	10,24 ₺
57026	70'lik U Klemens	40	13,32 ₺
57027	95'lik U Klemens	25	16,65 ₺
57028	120'lik U Klemens	20	17,90 ₺
57029	150'lik U Klemens	15	30,20 ₺



### TIRNAKLI KLEMENSLER

KOD	AÇIKLAMA	KUTU AD.	FİYAT ₺
57040	No:1 16 mm <sup>2</sup>	150	5,45 ₺
57041	No:2 25 mm <sup>2</sup>	100	5,90 ₺
57042	No:3 35 mm <sup>2</sup>	100	9,40 ₺
57043	No:4 50 mm <sup>2</sup>	50	13,95 ₺
57044	No:5 70 mm <sup>2</sup>	50	16,65 ₺
57045	No:6-7 95 mm <sup>2</sup>	25	37,50 ₺

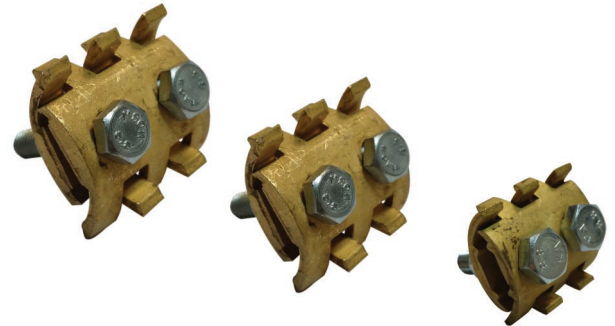

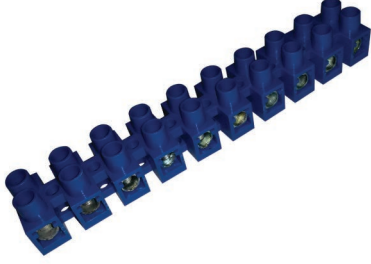

### PLASTİK SIRA KLEMENSLER

KOD	AÇIKLAMA	KUTU AD.	FİYAT ₺
E 22010	No: 1 2.5-4 mm'lik	50	5,26 ₺
E 22020	No: 2 4-6 mm'lik	50	5,98 ₺
E 22030	No: 3 6-10 mm'lik	50	7,52 ₺
E 22040	No: 4 10-16 mm'lik	50	9,00 ₺
E 22050	No: 5 16-25 mm'lik	50	11,27 ₺



### ISIYA DAYANIKLI SIRA KLEMENSLER

KOD	AÇIKLAMA	KUTU AD.	FİYAT ₺
E 22110	No: 1 2.5-4 mm'lik	50	5,80 ₺
E 22120	No: 2 4-6 mm'lik	50	6,70 ₺
E 22130	No: 3 6-10 mm'lik	50	8,24 ₺
E 22140	No: 4 10-16 mm'lik	50	10,00 ₺
E 22150	No: 5 16-25 mm'lik	50	12,38 ₺



### VİDALI ŞEFFAF BUAT İÇİ KLEMENSLER

KOD	AÇIKLAMA	KUTU AD.	FİYAT ₺
25500	No: 2 Vidalı Şeffaf Buat İçi Klemens	588	0,93 ₺
25501	No: 3 Vidalı Şeffaf Buat İçi Klemens	432	1,18 ₺
25502	No: 4 Vidalı Şeffaf Buat İçi Klemens	240	1,95 ₺
25503	No: 5 Vidalı Şeffaf Buat İçi Klemens	200	2,63 ₺
25504	No: 6 Vidalı Şeffaf Buat İçi Klemens	120	3,50 ₺
25505	No: 7 Vidalı Şeffaf Buat İçi Klemens	160	4,80 ₺
25506	No: 8 Vidalı Şeffaf Buat İçi Klemens	120	7,90 ₺



### BRANŞMAN KLEMENSLER

KOD	AÇIKLAMA	KUTU AD.	FİYAT (NORM) ₺
57057	A40 - A40 Branşman Klm.	100	8,36 ₺
57058	A70 - A70 Branşman Klm.	50	14,24 ₺
57059	A120 - A120 Branşman Klm.	50	23,35 ₺



### AL-CU KLEMENSLER

KOD	AÇIKLAMA	KUTU AD.	FİYAT (NORM) ₺
57050	A25 - B16 Al-Cu Klm.	100	12,00 ₺
57051	A40 - B25 Al-Cu Klm.	100	13,50 ₺
57052	A70 - B50 Al-Cu Klm.	50	30,80 ₺
57053	A120 - B70 Al-Cu Klm.	25	35,30 ₺



### STANDART BEYAZ/SİYAH KABLO BAĞLARI NAYLON 6,6

KOD	EBAT	EBAT BOY	RENK	MAKSİMUM SIKMA ÇAPİ (mm)	AÇILMA MUKAVEMETİ (kg)	KOLİ AD.	FİYAT ₺
KB 2,5-100M	2,5	100	Beyaz/Siyah	25	8	40.000	0,037 ₺
KB 2,5-150M	2,5	150	Beyaz/Siyah	35	8	20.000	0,056 ₺
KB 2,5-200M	2,5	200	Beyaz/Siyah	55	8	15.000	0,074 ₺
KB 3,6-150	3,6	150	Beyaz/Siyah	35	18	10.000	0,096 ₺
KB 3,6-200	3,6	200	Beyaz/Siyah	55	18	10.000	0,121 ₺
KB 3,6-250	3,6	250	Beyaz/Siyah	68	18	10.000	0,150 ₺
KB 3,6-300	3,6	300	Beyaz/Siyah	85	18	10.000	0,180 ₺
KB 3,6-370	3,6	370	Beyaz/Siyah	102	18	10.000	0,226 ₺
KB 4,8-200	4,8	200	Beyaz/Siyah	55	22	10.000	0,150 ₺
KB 4,8-250	4,8	250	Beyaz/Siyah	68	22	10.000	0,180 ₺
KB 4,8-300	4,8	300	Beyaz/Siyah	85	22	10.000	0,235 ₺
KB 4,8-380	4,8	380	Beyaz/Siyah	102	22	5.000	0,310 ₺
KB 4,8-400	4,8	400	Beyaz/Siyah	125	22	5.000	0,320 ₺
KB 7,6-300	7,6	300	Beyaz/Siyah	85	55	3.000	0,514 ₺
KB 7,6-380	7,6	380	Beyaz/Siyah	102	55	2.500	0,656 ₺
KB 7,6-450	7,6	450	Beyaz/Siyah	133	55	3.000	0,734 ₺
KB 7,6-550	7,6	550	Beyaz/Siyah	166	55	2.500	0,930 ₺
KB 9-750	9,0	750	Beyaz/Siyah	185	80	1.000	1,672 ₺
KB 9-950	9,0	950	Beyaz/Siyah	236	80	1.000	2,090 ₺



### KABLO YÜKSÜKLERİ İZOLELİ (TEK GİRİŞLİ)

KOD	ANMA ÖLÇÜ	KESİT	RENK	AMB. AD.	FİYAT ₺
HNR-İY-0,5	8 mm	0,50	Beyaz	1000	0,0557 ₺
HNR-İY-0,75	8 mm	0,75	Mavi	1000	0,0557 ₺
HNR-İY-1	8 mm	1	Kırmızı	1000	0,0588 ₺
HNR-İY-1,5	8 mm	1,5	Siyah	1000	0,0650 ₺
HNR-İY-2,5	8 mm	2,5	Gri	500	0,0817 ₺
HNR-İY-4	9 mm	4	Turuncu	500	0,1100 ₺
HNR-İY-6	12 mm	6	Yeşil	250	0,1600 ₺
HNR-İY-10	12 mm	10	Kahve	100	0,2500 ₺
HNR-İY-16	12 mm	16	Sütlü Kahve	100	0,3000 ₺
HNR-İY-25	16 mm	25	Siyah	50	0,6100 ₺
HNR-İY-35	16 mm	35	Kahve Yeşil	50	0,7300 ₺
HNR-İY-50	20 mm	50	Yeşil	25	1,3600 ₺
HNR-İY-70	20mm	70	Sarı	25	2,0000 ₺



### KABLO YÜKSÜKLERİ İZOLELİ (ÇİFT GİRİŞLİ)

KOD	ANMA ÖLÇÜ	KESİT	RENK	AMB. AD.	FİYAT ₺
HNR-CY-0,5	8 mm	2X0,50	Beyaz	1000	0,0904 ₺
HNR-CY-0,75	8 mm	2X0,75	Mavi	500	0,0904 ₺
HNR-CY-1	8 mm	2X1	Kırmızı	500	0,0938 ₺
HNR-CY-1,5	8 mm	2X1,5	Siyah	500	0,0988 ₺
HNR-CY-2,5	10 mm	2X2,5	Gri	250	0,1567 ₺
HNR-CY-4	12 mm	2X4	Turuncu	200	0,2214 ₺
HNR-CY-6	14 mm	2X6	Yeşil	100	0,3220 ₺
HNR-CY-10	14 mm	2X10	Kahve	100	0,4768 ₺
HNR-CY-16	14 mm	2X16	Sütlü Kahve	50	0,7300 ₺

### KABLO YÜKSÜKLERİ İZOLESİZ

KOD	ANMA ÖLÇÜ	KESİT	AMB. AD.	FİYAT ₺
HNR-KY-0,75	10 mm	0,75	1000	0,0427 ₺
HNR-KY-1	10 mm	1	1000	0,0443 ₺
HNR-KY-1,5	10 mm	1,5	1000	0,0511 ₺
HNR-KY-2,5	12 mm	2,5	1000	0,0613 ₺
HNR-KY-4	12 mm	4	500	0,0904 ₺
HNR-KY-6	12 mm	6	500	0,1236 ₺
HNR-KY-10	12 mm	10	250	0,1789 ₺
HNR-KY-16	12 mm	16	250	0,2043 ₺
HNR-KY-25	22 mm	25	100	0,4087 ₺
HNR-KY-35	25 mm	35	100	0,4768 ₺



### ÇATAL TİP İZOLELİ KABLO PABUÇ

KOD	Kesit mm <sup>2</sup>	ÖLÇÜ METRİK	RENK	KOLİ AD.	FİYAT ₺
HCU-3001	0,5-1,5	M3	Kırmızı	200	0,2200 ₺
HCU-4001	0,5-1,5	M4	Kırmızı	200	0,2200 ₺
HCU-5001	0,5-1,5	M5	Kırmızı	200	0,2340 ₺
HCU-6001	0,5-1,5	M6	Kırmızı	200	0,2550 ₺
HCU-3002	1,5-2,5	M3	Mavi	200	0,2500 ₺
HCU-4002	1,5-2,5	M4	Mavi	200	0,2540 ₺
HCU-5002	1,5-2,5	M5	Mavi	200	0,3000 ₺
HCU-6002	1,5-2,5	M6	Mavi	200	0,3100 ₺
HCU-4006	4-6,0	M4	Sarı	100	0,5250 ₺
HCU-5006	4-6,0	M5	Sarı	100	0,5300 ₺
HCU-6006	4-6,0	M6	Sarı	100	0,5325 ₺
HCU-8006	4-6,0	M8	Sarı	100	0,8600 ₺



### YUVARLAK TİP İZOLELİ KABLO PABUÇLARI

KOD	Kesit mm <sup>2</sup>	ÖLÇÜ METRİK	RENK	KOLİ AD.	FİYAT ₺
HEYU-301	0,5-1,5	M3	Kırmızı	200	0,2200 ₺
HEYU-351	0,5-1,5	M3	Kırmızı	200	0,2215 ₺
HEYU-401	0,5-1,5	M4	Kırmızı	200	0,2230 ₺
HEYU-501	0,5-1,5	M5	Kırmızı	200	0,2400 ₺
HEYU-601	0,5-1,5	M6	Kırmızı	200	0,3900 ₺
HEYU-801	0,5-1,5	M8	Kırmızı	200	0,3930 ₺
HEYU-302	1,5-2,5	M3	Mavi	200	0,2500 ₺
HEYU-402	1,5-2,5	M4	Mavi	200	0,2540 ₺
HEYU-502	1,5-2,5	M5	Mavi	200	0,2950 ₺
HEYU-602	1,5-2,5	M6	Mavi	200	0,4200 ₺
HEYU-802	1,5-2,5	M8	Mavi	200	0,4240 ₺
HEYU-1002	1,5-2,5	M10	Mavi	100	0,4770 ₺
HEYU-406	4-6,0	M4	Sarı	100	0,5100 ₺
HEYU-506	4-6,0	M5	Sarı	100	0,5800 ₺
HEYU-606	4-6,0	M5	Sarı	100	0,6400 ₺
HEYU-806	4-6,0	M5	Sarı	100	0,8800 ₺
HEYU-1006	4-6,0	M10	Sarı	100	0,8820 ₺
HEYU-510	8-10	M5	Kırmızı	100	1,2725 ₺
HEYU-610	8-10	M6	Kırmızı	100	1,2750 ₺



**PANO TOPRAKLAMA KLEMENSLERİ AYAKLI**  
(6,5x9 mm Kesit)

**80 Amp.**

KOD	AÇIKLAMA	L	KOLİ AD.	FİYAT ₺
1106	6 Delikli Ayaklı Klemensli	85	175	8,26 ₺
1107	7 Delikli Ayaklı Klemensli	90	150	9,00 ₺
1110	10 Delikli Ayaklı Klemensli	108	150	10,85 ₺
1112	12 Delikli Ayaklı Klemensli	120	125	11,80 ₺
1115	15 Delikli Ayaklı Klemensli	138	125	14,30 ₺
1120	20 Delikli Ayaklı Klemensli	165	100	18,60 ₺
1125	25 Delikli Ayaklı Klemensli	195	100	23,10 ₺
1130	30 Delikli Ayaklı Klemensli	235	80	32,20 ₺

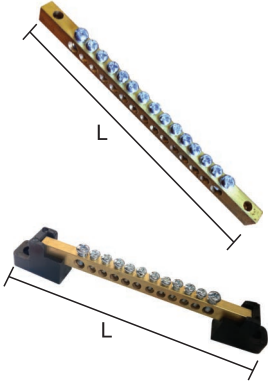
**PANO TOPRAKLAMA KLEMENSLERİ AYAKSIZ**  
Çift Taraftan Montaj Delikli (6,5x9 mm Kesit)

**80 Amp.**

KOD	AÇIKLAMA	L	KOLİ AD.	FİYAT ₺
1206	6 Delikli Ayaksız Klemens	52	250	7,94 ₺
1207	7 Delikli Ayaksız Klemens	57	250	8,80 ₺
1210	10 Delikli Ayaksız Klemens	78	200	10,40 ₺
1212	12 Delikli Ayaksız Klemens	88	150	12,00 ₺
1215	15 Delikli Ayaksız Klemens	105	150	14,00 ₺
1220	20 Delikli Ayaksız Klemens	134	100	18,35 ₺
1225	25 Delikli Ayaksız Klemens	165	50	22,85 ₺
1230	30 Delikli Ayaksız Klemens	194	50	32,00 ₺

**PANO TOPRAKLAMA KLEMENSLERİ AYAKLI**  
(7x12 mm Kesit)

**125 Amp.**

KOD	AÇIKLAMA	L	KOLİ AD.	FİYAT ₺
1306	6 Delikli Ayaklı Klemens	77	150	10,75 ₺
1307	7 Delikli Ayaklı Klemens	87	150	11,30 ₺
1310	10 Delikli Ayaklı Klemens	110	100	14,00 ₺
1312	12 Delikli Ayaklı Klemens	124	100	17,20 ₺
1315	15 Delikli Ayaklı Klemens	146	100	21,50 ₺
1320	20 Delikli Ayaklı Klemens	182	100	27,40 ₺
1325	25 Delikli Ayaklı Klemens	217	80	32,00 ₺
1330	30 Delikli Ayaklı Klemens	265	75	41,00 ₺

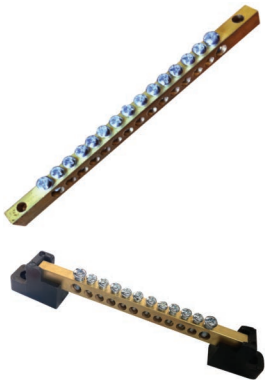
**PANO TOPRAKLAMA KLEMENSLERİ AYAKSIZ**  
Çift Taraftan Montaj Delikli (7x12 mm Kesit)

**125 Amp.**

KOD	AÇIKLAMA	L	KOLİ AD.	FİYAT ₺
1306A	6 Delikli Ayaksız Klemens	63	175	10,50 ₺
1307A	7 Delikli Ayaksız Klemens	69	175	11,00 ₺
1310A	10 Delikli Ayaksız Klemens	94	100	13,75 ₺
1312A	12 Delikli Ayaksız Klemens	119	100	17,00 ₺
1315A	15 Delikli Ayaksız Klemens	130	100	21,25 ₺
1320A	20 Delikli Ayaksız Klemens	165	100	27,20 ₺
1325A	25 Delikli Ayaksız Klemens	203	75	31,80 ₺
1330A	30 Delikli Ayaksız Klemens	235	50	40,80 ₺

**PANO TOPRAKLAMA KLEMENSLERİ AYAKSIZ**  
10x15 kesit

**160 Amp.**

KOD	CİNSİ	L	KOLİ AD.	FİYAT ₺
3380	7 Delik Ayaksız	100	100	33,80 ₺
3381	10 Delik Ayaksız	134	100	39,50 ₺
3382	12 Delik Ayaksız	157	75	47,20 ₺
3383	15 Delik Ayaksız	190	50	63,10 ₺
3384	20 Delik Ayaksız	265	50	81,15 ₺

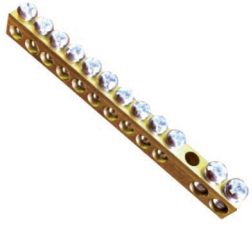

**PANO TOPRAKLAMA KLEMENSLERİ**  
1 metre boyunda

KOD	CİNSİ	L	KOLİ AD.	FİYAT ₺
3388	6,5x9 mlz.	1 m.	20	165,00 ₺
3389	7x12 mlz.	1 m.	20	195,00 ₺

**GRUP TOPRAKLAMA**  
6,5x9 kesit

**80 Amp**

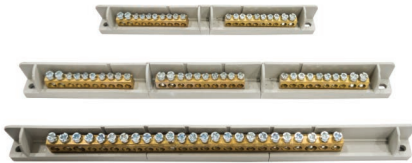
KOD	CİNSİ	L	KOLİ AD.	FİYAT ₺
3330	3x10	262	100	37,50 ₺
3332	2x10	262	100	34,80 ₺
3333	2x15	262	100	36,30 ₺
3334	1x20	262	100	33,00 ₺
3335	1x25	262	100	43,00 ₺
3336	1x30	262	100	51,50 ₺

**GRUP TOPRAKLAMA**  
7x12 kesit

**100 Amp**

KOD	CİNSİ	L	KOLİ AD.	FİYAT ₺
3340	3x7	262	100	47,20 ₺
3341	2x10	262	100	45,00 ₺
3342	2x12	262	100	49,40 ₺
3343	2x15	262	100	62,25 ₺
3344	1x20	262	100	45,00 ₺
3345	1x25	262	100	51,50 ₺



### 10 KABLO KESİTLİ 2 KUTUPLU DAĞITIM ÜNİTESİ (6,5x9 mm Kesit)

80 Amp.

KOD	AÇIKLAMA	L	B	H	KOLİ AD.	FİYAT ₺
80-1407	2+5	63	45	47	22	37,15 ₺
80-1410	2+8	83	45	47	15	41,60 ₺
80-1412	2+10	94	45	47	14	46,20 ₺
80-1415	2+13	110	45	47	12	60,80 ₺
80-1420	2+18	140	45	47	6	79,00 ₺
80-1422	2+20	151	45	47	6	83,40 ₺



### 10 KABLO KESİTLİ 4 KUTUPLU DAĞITIM ÜNİTESİ (6,5x9 mm Kesit)

ALÇAK MODEL

80 Amp.

KOD	AÇIKLAMA	L	B	H	KOLİ AD.	FİYAT ₺
80-1607	2+5	65	90	50	10	81,24 ₺
80-1610	2+8	87	90	50	8	83,40 ₺
80-1612	2+10	102	90	50	6	94,50 ₺
80-1615	2+13	126	90	50	5	115,00 ₺
80-1620	2+18	162	90	50	4	144,00 ₺
80-1622	2+20	175	90	50	4	150,00 ₺
80-1625	2+23	197	90	50	4	156,70 ₺



### 10 KABLO KESİTLİ 4 KUTUPLU DAĞITIM ÜNİTESİ (6,5x9 mm Kesit)

YÜKSEK MODEL

80 Amp.

KOD	AÇIKLAMA	L	B	H	KOLİ AD.	FİYAT ₺
80-1507	2+5	60	80	75	10	79,00 ₺
80-1510	2+8	83	80	75	8	83,70 ₺
80-1512	2+10	92	80	75	6	95,80 ₺
80-1515	2+13	114	80	75	5	117,00 ₺
80-1520	2+18	154	80	75	4	153,75 ₺
80-1522	2+20	160	80	75	4	164,50 ₺
80-1525	2+23	198	80	75	4	191,50 ₺

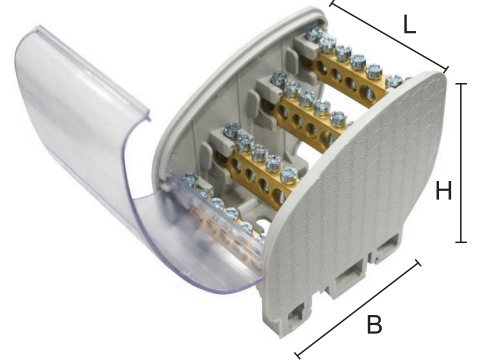

### BAKIR NÖTR TOPRAK EŞ POTANSİYEL BARALAR 250 AMPER 5X20

(İZALATÖR AYAKLI)

KOD	cinsi	L	B	H	KOLİ AD.	FİYAT ₺
3608	1 Giriş 7 Çıkış	200	-	95	100	85,90 ₺
3611	1 Giriş 10 Çıkış	260	-	95	75	99,00 ₺
3615	1 Giriş 14 Çıkış	335	-	95	50	128,80 ₺



### BAKIR NÖTR TOPRAK EŞ POTANSİYEL BARALAR 250 AMPER 5X20

(PLASTİK AYAKLI)

KOD	cinsi	L	B	H	KOLİ AD.	FİYAT ₺
3708	1 Giriş 7 Çıkış	220	40	39	100	69,70 ₺
3711	1 Giriş 10 Çıkış	270	40	39	75	85,80 ₺
3715	1 Giriş 14 Çıkış	345	40	39	50	107,30 ₺



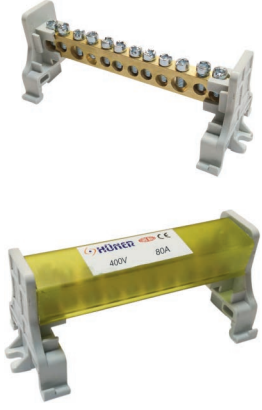

### 1 KUTUP DAĞITICI ÜNİTELER RAY GEÇMELİ KAPAKSIZ 6,5x9 mm 80 Amp

KOD	AÇIKLAMA	L	KOLİ AD.	FİYAT ₺
1706	2+4 6 Delikli Ünite	60	80	13,54 ₺
1707	2+5 7 Delikli Ünite	66	70	14,20 ₺
1710	2+8 10 Delikli Ünite	82	65	15,85 ₺
1712	2+10 12 Delikli Ünite	100	55	18,80 ₺
1715	2+13 15 Delikli Ünite	115	45	22,55 ₺
1720	2+18 20 Delikli Ünite	142	30	31,55 ₺
1725	2+23 25 Delikli Ünite	185	25	39,10 ₺
1730	2+28 30 Delikli Ünite	215	25	45,60 ₺

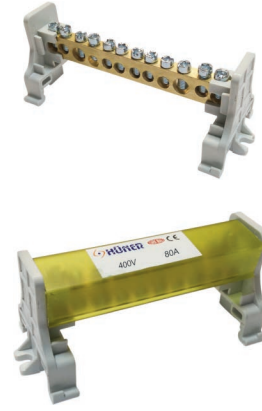

### 1 KUTUP DAĞITICI ÜNİTELER RAY GEÇMELİ KAPAKSIZ 7x12 mm 125 Amp

KOD	AÇIKLAMA	L	KOLİ AD.	FİYAT ₺
1907	2+5 7 Delikli Ünite	75	65	15,85 ₺
1910	2+8 10 Delikli Ünite	100	55	18,90 ₺
1912	2+10 12 Delikli Ünite	115	45	22,55 ₺
1915	2+13 15 Delikli Ünite	135	30	27,00 ₺
1920	2+18 20 Delikli Ünite	170	30	37,80 ₺
1922	2+20 22 Delikli Ünite	185	25	42,10 ₺
1925	2+23 25 Delikli Ünite	207	25	45,00 ₺
1930	2+28 30 Delikli Ünite	245	20	52,60 ₺

### 1 KUTUP DAĞITICI ÜNİTELER RAY GEÇMELİ KAPAKLI 6,5x9 mm 80 Amp

KOD	AÇIKLAMA	L	KOLİ AD.	FİYAT ₺
1806	2+4 6 Delikli Ünite	60	70	15,00 ₺
1807	2+5 7 Delikli Ünite	66	60	15,85 ₺
1810	2+8 10 Delikli Ünite	82	55	21,00 ₺
1812	2+10 12 Delikli Ünite	100	45	25,30 ₺
1815	2+13 15 Delikli Ünite	115	35	31,55 ₺
1820	2+18 20 Delikli Ünite	142	25	36,00 ₺
1825	2+23 25 Delikli Ünite	185	20	45,00 ₺
1830	2+28 30 Delikli Ünite	215	20	62,25 ₺

### 1 KUTUP DAĞITICI ÜNİTELER RAY GEÇMELİ KAPAKLI 7x12 mm 125 Amp

KOD	AÇIKLAMA	L	KOLİ AD.	FİYAT ₺
2007	2+5 7 Delikli Ünite	75	60	18,90 ₺
2010	2+8 10 Delikli Ünite	100	40	22,60 ₺
2012	2+10 12 Delikli Ünite	115	40	26,40 ₺
2015	2+13 15 Delikli Ünite	135	30	30,00 ₺
2020	2+18 20 Delikli Ünite	170	25	42,10 ₺
2022	2+20 22 Delikli Ünite	185	20	46,60 ₺
2025	2+23 25 Delikli Ünite	207	15	52,60 ₺
2030	2+28 30 Delikli Ünite	245	15	60,00 ₺



### 4 KUTUP 7x12 KESİT 125 AMP DAĞITICI ÜNİTELER (AYAK GEÇMELİ)

ALÇAK MODEL

KOD	CİNSİ	L	B	H	KOLİ AD.	FİYAT ₺
4307	2+5	105	144	55	12	118,00 ₺
4310	2+8	145	144	55	8	172,00 ₺
4312	2+10	165	144	55	8	204,00 ₺
4315	2+13	200	144	55	6	253,00 ₺
4320	2+18	255	144	55	4	339,00 ₺
4322	2+20	275	144	55	4	344,00 ₺

### 4 KUTUP 10x15 KESİT 160 AMP DAĞITICI ÜNİTELER (AYAK GEÇMELİ)

ALÇAK MODEL

KOD	CİNSİ	L	B	H	KOLİ AD.	FİYAT ₺
3207	2+5	105	144	55	12	146,00 ₺
3210	2+8	145	144	55	8	212,50 ₺
3212	2+10	165	144	55	8	253,00 ₺
3215	2+13	200	144	55	6	313,00 ₺
3220	2+18	255	144	55	4	419,00 ₺
3222	2+20	275	144	55	4	425,00 ₺

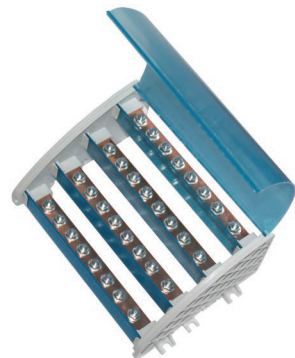

### 4 KUTUP 200 AMPER 3x15 BAKIR BARALAR

KOD	CİNSİ	L	B	H	KOLİ AD.	FİYAT ₺
3508	1 Giriş 7 Çıkış	220	150	95	6	232,00 ₺
3511	1 Giriş 10 Çıkış	280	150	95	4	260,00 ₺
3515	1 Giriş 14 Çıkış	354	150	95	4	303,00 ₺

### 4 KUTUP 250 AMPER 5x20 BAKIR BARALAR

KOD	CİNSİ	L	B	H	KOLİ AD.	FİYAT ₺
3408	1 Giriş 7 Çıkış	220	150	95	6	265,00 ₺
3411	1 Giriş 10 Çıkış	280	150	95	4	305,00 ₺
3415	1 Giriş 14 Çıkış	354	150	95	4	330,00 ₺

## ECO SİYAH PLASTİK SİRAL BORULAR

KOD	AÇIKLAMA	AMBALAJ (mt.)	FİYAT ₺
KR 012	Ø11 mm Siyah Plastik Spiral Boru	100	0,687 ₺
KR 014	Ø14 mm Siyah Plastik Spiral Boru	100	0,774 ₺
KR 016	Ø16 mm Siyah Plastik Spiral Boru	100	0,960 ₺
KR 020	Ø20 mm Siyah Plastik Spiral Boru	100	1,207 ₺
KR 026	Ø26 mm Siyah Plastik Spiral Boru	50	1,486 ₺
KR 032	Ø32 mm Siyah Plastik Spiral Boru	50	2,167 ₺
KR 040	Ø40 mm Siyah Plastik Spiral Boru	25	3,100 ₺



Siyah Plastik Spiral Borular Klavuz Telli İçin Liste Fiyatına 35 Kr. İlave Ediniz.

## PLUS PLASTİK SİRAL BORULAR

KOD	AÇIKLAMA	RENK	AMBALAJ (mt.)	FİYAT ₺
KR 012P	Ø12 mm Renkli Plastik Spiral Boru	●●	100	0,755 ₺
KR 014P	Ø14 mm Renkli Plastik Spiral Boru	●●	100	0,867 ₺
KR 016P	Ø16 mm Renkli Plastik Spiral Boru	●●	100	1,065 ₺
KR 020P	Ø20 mm Renkli Plastik Spiral Boru	●●	100	1,337 ₺
KR 026P	Ø26 mm Renkli Plastik Spiral Boru	●●	50	1,672 ₺
KR 032P	Ø32 mm Renkli Plastik Spiral Boru	●●	50	2,415 ₺
KR 040P	Ø40 mm Renkli Plastik Spiral Boru	●●	25	3,400 ₺

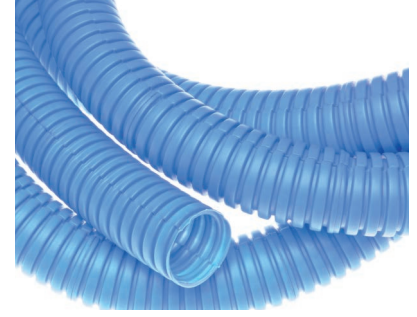

## HALOJEN FREE PLASTİK SİRAL BORULAR (ALEV YAYAN)

KOD	AÇIKLAMA	AMBALAJ (mt.)	FİYAT ₺
KR 312	Ø12 mm HF Renkli Plastik Spiral Boru	100	1,362 ₺
KR 314	Ø14 mm HF Renkli Plastik Spiral Boru	100	1,610 ₺
KR 316	Ø16 mm HF Renkli Plastik Spiral Boru	100	2,043 ₺
KR 320	Ø20 mm HF Renkli Plastik Spiral Boru	100	2,539 ₺
KR 326	Ø26 mm HF Renkli Plastik Spiral Boru	50	3,096 ₺
KR 332	Ø32 mm HF Renkli Plastik Spiral Boru	50	4,458 ₺
KR 340	Ø40 mm HF Renkli Plastik Spiral Boru	25	6,500 ₺



## ÇELİK SİRAL BORULAR

KOD	AÇIKLAMA	AMBALAJ (mt.)	FİYAT ₺
KR 409	Ø9 mm Çelik Spiral Boru	50	2,167 ₺
KR 411	Ø11 mm Çelik Spiral Boru	50	2,640 ₺
KR 414	Ø14 mm Çelik Spiral Boru	50	2,970 ₺
KR 416	Ø16 mm Çelik Spiral Boru	50	3,340 ₺
KR 418	Ø18 mm Çelik Spiral Boru	50	3,715 ₺
KR 421	Ø21 mm Çelik Spiral Boru	50	4,330 ₺
KR 426	Ø26 mm Çelik Spiral Boru	25	5,570 ₺
KR 429	Ø29 mm Çelik Spiral Boru	25	6,190 ₺
KR 432	Ø32 mm Çelik Spiral Boru	25	6,810 ₺
KR 437	Ø37 mm Çelik Spiral Boru	25	8,421 ₺
KR 442	Ø42 mm Çelik Spiral Boru	25	10,520 ₺
KR 450	Ø50 mm Çelik Spiral Boru	25	13,000 ₺

## İZOLELİ ÇELİK SİRAL BORULAR

KOD	AÇIKLAMA	AMBALAJ (mt.)	FİYAT ₺
KR 609	Ø9 mm İzoleli Çelik Spiral Boru	50	3,100 ₺
KR 611	Ø11 mm İzoleli Çelik Spiral Boru	50	3,282 ₺
KR 614	Ø14 mm İzoleli Çelik Spiral Boru	50	3,960 ₺
KR 616	Ø16 mm İzoleli Çelik Spiral Boru	50	4,335 ₺
KR 618	Ø18 mm İzoleli Çelik Spiral Boru	50	4,950 ₺
KR 621	Ø21 mm İzoleli Çelik Spiral Boru	50	6,375 ₺
KR 626	Ø26 mm İzoleli Çelik Spiral Boru	25	7,000 ₺
KR 629	Ø29 mm İzoleli Çelik Spiral Boru	25	8,000 ₺
KR 632	Ø32 mm İzoleli Çelik Spiral Boru	25	9,600 ₺
KR 637	Ø37 mm İzoleli Çelik Spiral Boru	25	10,774 ₺
KR 642	Ø42 mm İzoleli Çelik Spiral Boru	25	13,000 ₺
KR 650	Ø50 mm İzoleli Çelik Spiral Boru	25	17,330 ₺

Klavuz Telli İçin Liste Fiyatına 35 Kr. İlave Ediniz.

